

Product Specification

Material

Brass Material, Chrome Finished

Product Capability

Cartridge : Cold Ceramic Cartridge Hent
Durable test : 500,000 cycles
(Based on ASME A 112. 18. 1 - 2008)
Maximum Pressure : 7 kg/cm²
Maximum Temperature : 90°C
Working Pressure : ½ - 4 kg/cm²

Package Include

Brass Body
SS Ring Cap

PUB Approved

Water Efficiency : Excellent ✓✓✓
Water Consumption : 4.00 liter/min
Registration No : SKT/BT-2016/020605



Technical Drawing

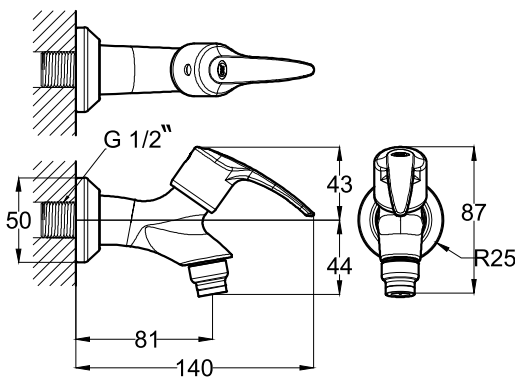

Installation Details

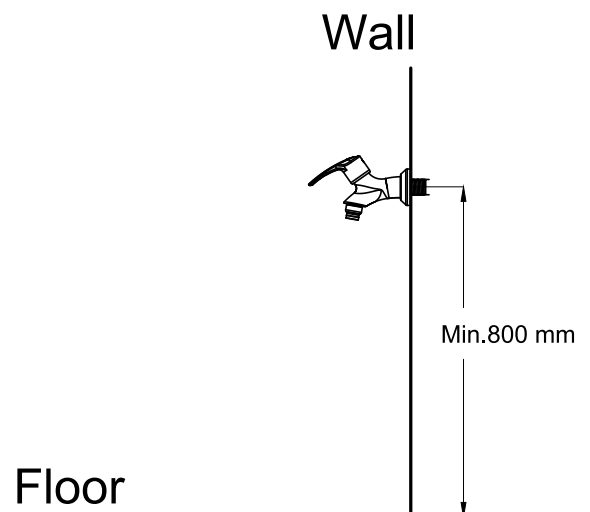

Disclaimer : While we endeavor to provide the most accurate, up-to-date information available, the content on this document may be change due to requirements in different sites, markets and/or countries, out of date or include omissions, inaccuracies or other errors. All content is subject to change without prior notice.